

Delivery Programme



Couplings



Belt Drives



Drive Components

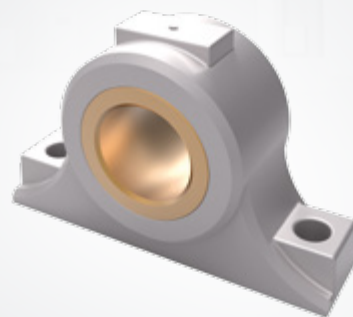

Bearings

Couplings



Habix® couplings
type HWN
type HWT with
taper bushes

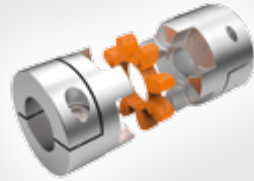

Habix®plus couplings
type HPN
type HPK



Hadeflex® couplings
type X
type TX



HRC couplings



Hadeflex® couplings
type F



PEX couplings



Orpex® couplings



Flex couplings



Clamp couplings
DIN 115



Flange couplings
DIN 116



Clamp couplings
steel/stainless steel
one-piece/two-piece design



Mini couplings



GC gear couplings
GC ECO gear couplings



Ferroflex-N couplings



E-Shop

You can order all products from this brochure around the clock online.
www.tecnamic.com/portal

Belt Drives



Standard pulleys
& taper bushes



Special pulleys



WSO V-belt pulleys

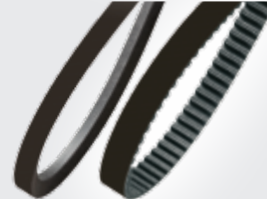

V-belts
Timing belts

Drive Components

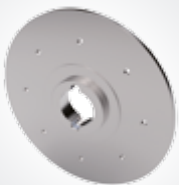

Bolt-on hubs
for taper bushes



Weld-on hubs
for taper bushes



Motor sliders made of
cast iron EN-GJL-200

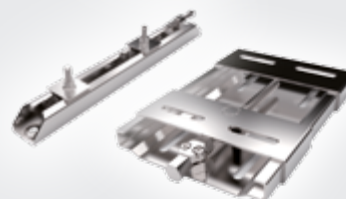

Motor mounts and motor
slides made of steel

Bearings

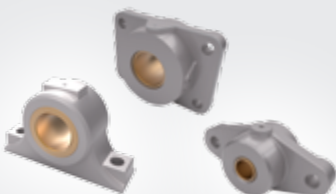

Eye type bearings DIN 504
Flange bearings DIN 502
Flange bearings DIN 503
– with or without bronze bush

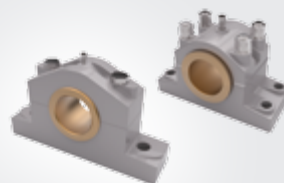

Cap bearings DIN 505 L
Cap bearings DIN 506
– with bronze shell

Tecnamic GmbH

Zunftweg 4
59457 Werl
Germany

T +49 2922 9273-888
F +49 2922 9273-880
E info@tecnamic.com



TECNAMIC

www.tecnamic.com